

## Research Article

## Fabrication of PANI by Electropolymerization Method on SnO<sub>2</sub> Conductive Glass as Counter Electrode for Dye sensitive Solar Cell

Wasan R. Saleh<sup>A</sup>, Abdulkareem M. Ali<sup>B</sup>, Thamir A. A. Hassan<sup>A</sup>, Ahmed A. Assi<sup>A\*</sup>, and Salma M. Hassan<sup>A</sup>

<sup>A</sup>Physics Department, Collage of science, University of Baghdad, Iraq.

<sup>B</sup>Chemical Department, Collage of science, University of Baghdad, Iraq

Accepted 16 Nov 2014, Available online 01 Dec 2014, Vol.4, No.6 (Dec 2014)

### Abstract

In this study, novel Polyaniline polymer (PANI) was deposited on SnO<sub>2</sub> conductive glass which prepared to act as counter electrode in dye sensitized solar cell (DSSC). The counter electrode was characterized using Fourier Transform Infrared and UV-Vis spectrometers. A simple method was used to synthesis PANI film consist from two electrodes after take optimum voltage for Polymerization of Aniline by using potentiostat. The film showed high adhesion on the SnO<sub>2</sub> conductive glass in compare with ITO conductive glass, led to higher incident photon to current conversion efficiency (IPCE) in solar cell. The efficiencies values were 46% and 52% for the films deposited on SnO<sub>2</sub> glass and ITO glass respectively. The cost ratio of used SnO<sub>2</sub> in comparison with ITO conductive glass is 1:5 by price. This gave economy preference to deposited PANI on SnO<sub>2</sub> conductive glass in fabrication of DSSC.

**Keywords:** PANI, SnO<sub>2</sub>, ITO, DSSC.

### Introduction

The photo electrochemical devices like dye sensitized solar cells (DSSCs) are the promising photovoltaic device for the utilization of solar into electricity energy by converting solar radiation through the generation of photo generated carriers. DSSCs possess the benign properties of low cost, high conversion efficiency and ease of fabrication (M. Grätzel, 2005; J. Frank and N. Kopidakis, 2004). Several significant advantages are associated to DSSCs such as the semiconductor-electrolyte interface (SEI) is easy to manufacture and it is cost effective for production, non-sensitive to the defects. Although, DSSCs are the promising photovoltaic technology for achieving reasonably high conversion efficiency but the improvements are still demanded to develop a high potential technology. Nanocrystalline metal oxide semiconductor like TiO<sub>2</sub>, ZnO and SnO<sub>2</sub> etc have been accepted as the effective photocathode materials for DSSCs due to their good optical and electronic properties. Polyaniline polymer is probably the eldest known electro conducting polymer, since it was used for textile coloring one century ago (M. Grätzel, 2000; Gordon G. Wallace and *et al*, 2008). The great interest in research of PANI is connected to discovery of its conductivity in the form of emeraldine salt and existence of different oxidation forms (G. Wallace and *et al*, 2008; Inzelt Gytöy, 2012).

In this work, PANI was used as counter electrode in DSSC. The DSSCs was fabricated with PANI and the nanostructured metal oxide TiO<sub>2</sub>, and compare with other

one based on TiO<sub>2</sub> only. On the other hand, the polymers are found as the potential candidates for replacing the liquid electrolyte in DSSCs and discussed for enhancing the properties of DSSC. Unlike other know electroconducting polymers, PANI can exist, depending on degree of oxidation, in different forms, known as: leucoemeraldine, emeraldine and perningraniline. Leucoemeraldine, The only conducting form of PANI is emeraldin salt, obtained by doping or protonation of emeraldine base (Fedorko P. and *et al*, 2010; Macdiarmid A. and *et al*, 1987). Ameen *et al* developed a simple interfacial polymerization method for the synthesis of PANI nanofibers (NFs) and its doping with sulfuric acid (SFA) to increase the conductivity (S.Ameen and *et al*, 2010). These undoped and SFA doped PANI NFs were applied as new counter electrodes materials for the fabrication of the highly efficient DSSCs. The selection of SFA was based on its exclusively important properties such as high solubility, easy handling, nonvolatile stable solid acid, and low corrosiveness (A. Sadia, A.M. Shaheer and *et al*, 2011).

### Experiment

Nano-Titanium dioxide (TiO<sub>2</sub>) of particle size 10-15 nm and purity 99.986 % were purchased from TECNAN Company. Pt foil The purity 99.7% ; thickness 0.25mm, Ethylene Glycol has purity 99.8%, and Aniline(C<sub>6</sub>H<sub>5</sub>NH<sub>2</sub>) has purity 90% from Sigma Aldrich of U.K. Sulfuric Acid (H<sub>2</sub>SO<sub>4</sub>) of purity 98% from (GCC) U.K, potassium iodide (KI ) has purity 99%, Iodine (I ) with purity 99.5%. ITO conductive glass of 10 Ω/cm<sup>2</sup> resistivity has

\*Corresponding author: **Ahmed A. Assi** (a\_a\_aa\_91@hotmail.com)

thickness(1.1mm), SnO<sub>2</sub> conductive glass of 250 Ω/cm<sup>2</sup> resistivity has thickness(1.3mm) and Polyethylene glycol(4000) H(OCH<sub>2</sub>CH<sub>2</sub>)<sub>n</sub>O<sub>4</sub> from HIMEDIA Company.

**Preparation electrolyte**

Gel-electrolyte prepared from Polyethylene glycol (PEG4000) as the high-molecular additive, ACN as the solvent, KI as the iodide and I<sub>2</sub> by rate 3 g: 15ml: 2gm: 0.2gm respectively (Sreekala and et al, 2013).

**Preparation of photoelectrode (TiO<sub>2</sub>/Dye):**

TiO<sub>2</sub> was deposited on ITO glass having resistance of 10 Ω/cm<sup>2</sup> by Doctor blend method and sintered in 450°C for 30 minutes. The working electrode (TiO<sub>2</sub> electrode) was immersed in freshly natural dyes from pomegranate for 30 minutes.

**Fabrication of PANI counter electrode**

The SnO<sub>2</sub> conductive glass was mounted in the working electrode holder that it was fabricated. Nanostructure PANI films have been successfully grown on SnO<sub>2</sub> conductive glass using the cyclic voltammetry (CV) method or electrochemical polymerization method at room temperature. the SnO<sub>2</sub> conductive glass acted as the working electrode in the three-electrode system Pt auxiliary electrode, and Ag/AgCl represents the reference electrode. These electrodes were immersed in The aqueous solution electrolyte containing 0.3M/L aniline and 1.0M H<sub>2</sub>SO<sub>4</sub> was prepared. CV was carried out using a Potentiostat and cell system to deposit PANI onto the SnO<sub>2</sub> glass. PANI films were fabricated by potential controlling from -50 mV to 1500 mV at scan rate 30 mV/sec for 6 cycles and duration 1:30 mints.

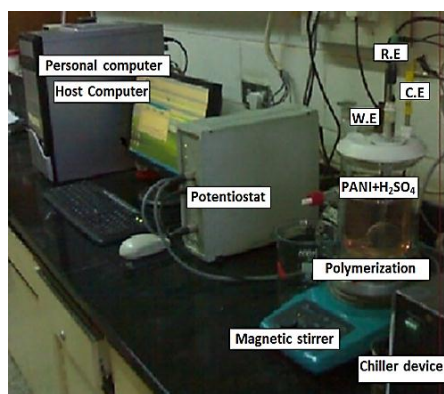

**Figure 1:** The complete system setup of cyclic polymerization process

The PANI nanofibers /SnO<sub>2</sub> electrode was fabricated by electro polymerization of aniline monomer in sulfuric acid using computer controlled three electrodes potentiostat, the repetition cycles was 5. The complete system setup of potentiostat is shown in figure 1. From cyclic Voltagram of the preparation polyaniline counter electrode that shown in figure 2 we fined The optimum voltage for polymerization of aniline by using potentiostat is1.3 Volt,

after find the optimum voltage for polymerization used simple electric circuit for deposition PANI on the SnO<sub>2</sub> conductive glass in place of potentiostat for speed deposit where taking sheet of platinum (Pt) by same area of conductive glass and immersion them in aniline aqueous solution, the simple electric circuit shown in figure (3a) then applied 1.3 volt DC for 6 min.

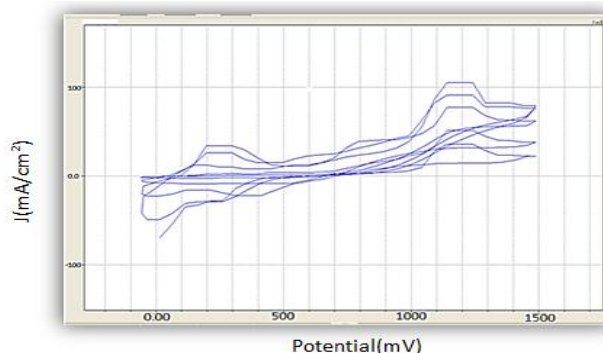

**Figure 2:** Cyclic voltagram of preparation PANI/SnO<sub>2</sub> counter electrode

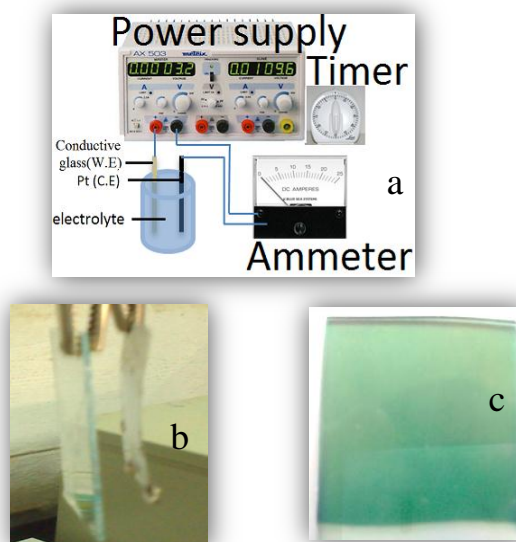

**Figure 3:** Simple device for polymerization of aniline (a) the simple electric circuit for polymerization (b) two electrodes (c) final electrode

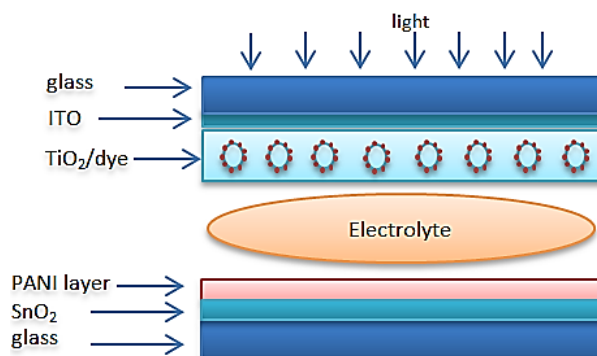

**Figure 4:** Schematic of a dye solar cell that prepared and used in this study

This arrangement will formed thin layer from conductive green PANI polymer film on the SnO<sub>2</sub> conductive glass. Figure 3c show green PANI electrode where the conducting protonated emeraldine in the form of green emeraldine salt (Sreekala and *et al*, 2013; Macdiarmid A. and *et al*, 1987).

Fabrication of polyaniline film on SnO<sub>2</sub> conductive glass for the purpose of using as a counter electrode for dye sensitive solar cell to improve the conversion efficiency. Figure 4 show the assembled layers of the fabricated DSSC.

## Results and Discussion

The crystal structure of the deposited PANI was examined by X-ray diffraction (XRD). Figure 5 show the XRD pattern for PANI doped with H<sub>2</sub>SO<sub>4</sub> in electrochemical synthesis. It is clear that the diffraction pattern of PANI has broad scattering peaks around 2θ of 25.51° which may correspond to the (110) plane of PANI. This result identity with the result of (J. Vivekanandan and *et al*, 2011).

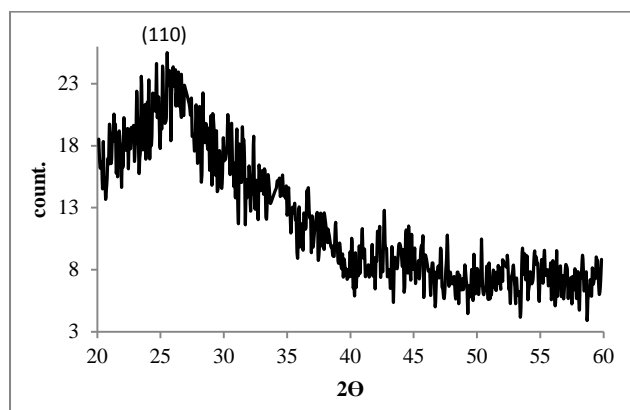

**Figure 5:** X-ray diffraction pattern of the PANI doped with H<sub>2</sub>SO<sub>4</sub>

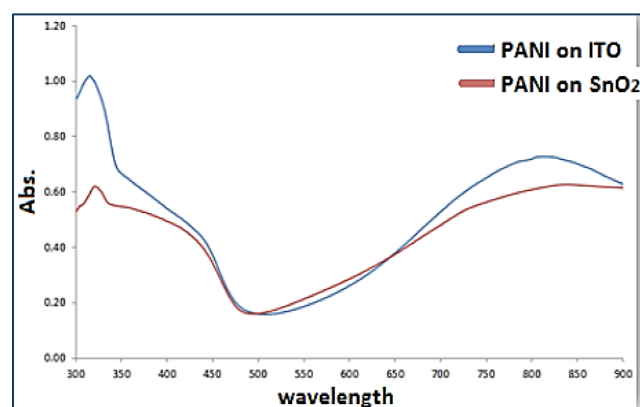

**Figure 6:** The UV-Vis absorption spectra of PANI coated on ITO and SnO<sub>2</sub> conductive glasses

Figure 6. shows the UV-VIS absorption spectra of PANI coated on ITO and SnO<sub>2</sub> conducting glasses. The band observed at 300-355 nm for the both cases corresponds to n-p\* transitions of aniline, while the broad band at 600-620 nm is due to n-p\* transitions of quinone-imine groups

(J. Vivekanandan and *et al*, 2011). the absorption intensity for PANI on ITO conductive glass is higher due to the regular arrangement of monomer units in electrochemical polymerization.

The FTIR studies for the prepared and standard PANI were carried out by FTIR spectrophotometer (8400 maximum resolution 0.5 cm<sup>-1</sup> Shimadzu Japan). Figure 7 shows the comparison FTIR spectrum of prepared PANI at room temperature and standard PANI. The characteristic of FTIR can distinguish between benzenoid rings and quinoid rings in the (1300-1600) cm<sup>-1</sup> region of the spectrum. This region of the spectrum is most useful for distinguishing between oxidation state in the normal, and doped polymer. As the quinoid stretches (1380 cm<sup>-1</sup>) disappear in the doping case, but it clearly appears in case of emeraldine and this is agreement with (J. Vivekanandan and *et al*, 2011).

The 1139 cm<sup>-1</sup> band is vibrational mode of (B-NH=Q) and (B=NH-Q) which is formed in doping reaction. this band is very intense and broad which may be attributed to an existence of positive charges (Y.Cao, P. Smith and A.J Heeger, 1989).

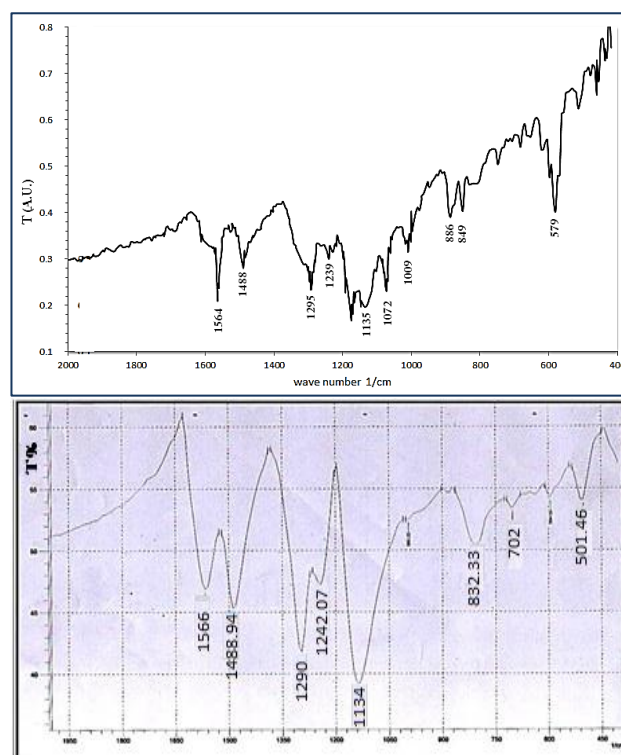
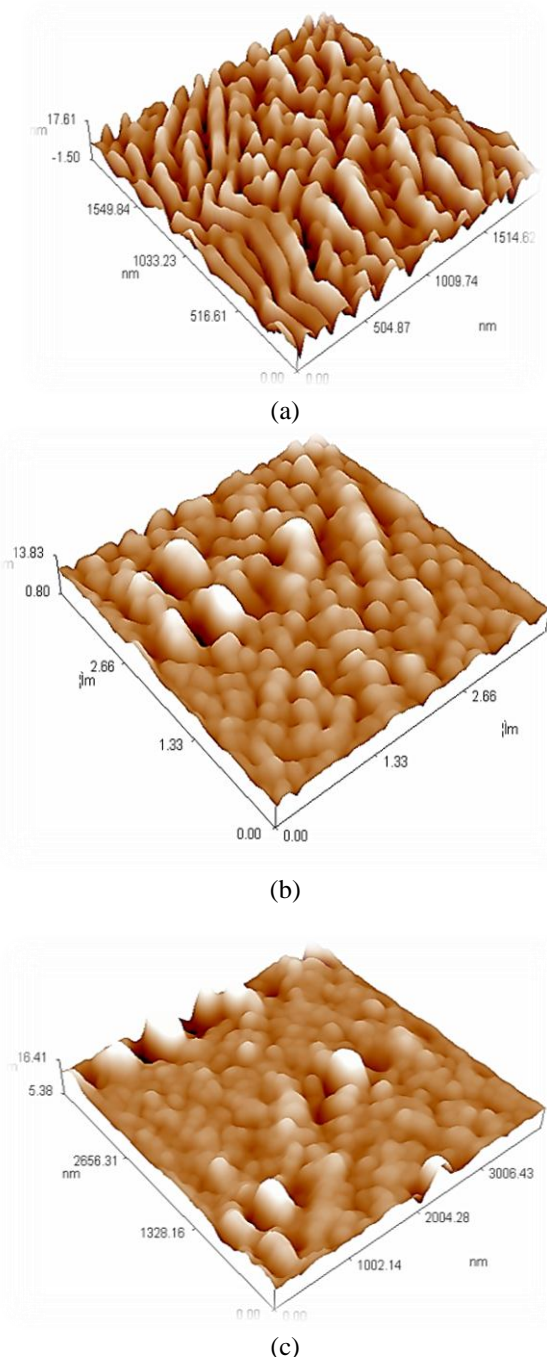

**Figure 7:** FTIR spectra PANI (a) Prepared PANI prepared (b) Stander PANI

**Table 1:** The observed peak for the prepared PANI

Peak wave number (cm <sup>-1</sup> )	Assignment
586-800	C-Cl Aromatics out of plain bend
1139	C=N Imines bending
1292	C-N stretch of benzenoid ring
1488	C=C benzenoid ring stretch(N-B-N)
1558-1566	C=C stretch of quinoid ring (N=Q=N)

The absorption peaks at 1564 cm<sup>-1</sup> assigned to the quinoid structure, that concludes that the polymers were prepared using di and tri basic acids. It has been reported that H<sub>2</sub>SO<sub>4</sub> may interact with PANI by donating either hydrogen sulfate, (HSO<sub>4</sub>)<sup>-</sup> or sulfate, (SO<sub>4</sub>)<sup>-2</sup> anions as dopant anions as shown in figure 3 Many authors agreed that (HSO<sub>4</sub>)<sup>-</sup> dopant anions are present in PANI/H<sub>2</sub>SO<sub>4</sub> (M. Wan, 2004). Table (1) show the observed peaks for the prepared PANI. Figure 8 show three dimensional AFM image of the surface topography of PANI, SnO<sub>2</sub> and ITO film respectively. The image show that the surface roughness average (Sa) is very small which indicate all films have smooth surface and displayed the angular structure.



**Figure 8:** AFM image in three diminitions of surfaces (a)PANI, (b) SnO<sub>2</sub>, (c) ITO

Other surface topography parameters such as root mean square roughness (Sq), ten point height (Sz) and average particle size, which estimated from the granularity copulation distribution are summarized in table (2).

**Table 2:** surface topography parameters obtained from AFM analysis for SnO<sub>2</sub> and ITO surfaces

Sample	Sa (nm)	Sq (nm)	Sz (nm)	Ave. G.S. (nm)
SnO <sub>2</sub>	1.24	1.67	7.84	239
ITO	0.934	1.42	6.23	212

While for PANI, the surface roughness average (Sa) is 2.96 nm and it reveals a film of nanofibers with diameter around 72.23 nm. The root mean square roughness (sq) is about 3.66 nm. while the ten point height (s<sub>z</sub>) is about 17.5 nm.

The SEM image of the prepared PANI was taken by SEM (Hitachi FE-SEM model S-4160, Japan). The image shows a Nano fiber of 72.23nm in diameter and length several microns, as well as nanoflowers like as the structure figure 9. This structure offers a large area to help in receiving the electron which injected by the dye to the titania layer, then return back to the dye again via the oxidation-reduction reactions of the I<sup>-</sup>/I<sub>3</sub><sup>-</sup> electrolyte.

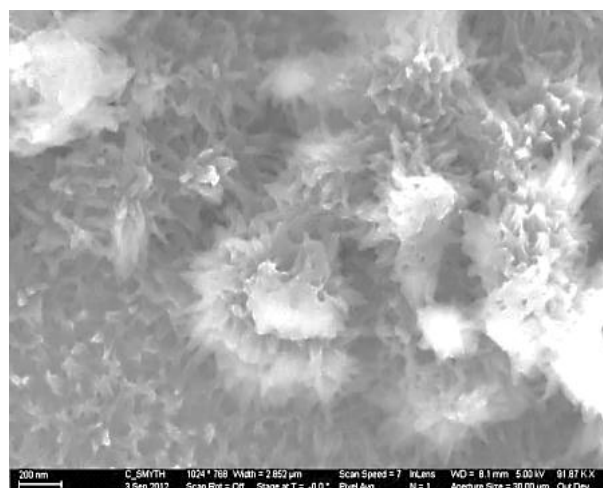
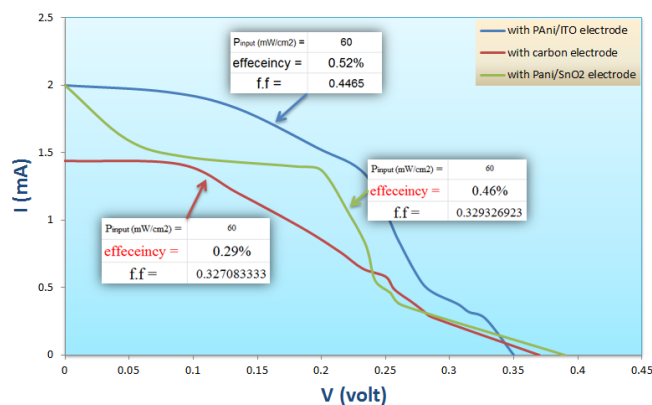

**Figure 9:** SEM image of the prepared polyaniline electrode

The PANI deposition on ITO and SnO<sub>2</sub> conductive glass but the adhesion of PANI on surface SnO<sub>2</sub> conductive glass stronger than on ITO conductive glass, table 1 show the roughness of SnO<sub>2</sub> larger than ITO perhaps that reason for adhesion on SnO<sub>2</sub>.

The I-V characteristic were measured by using three types of electrode; carbon, PANI on ITO and PANI on SnO<sub>2</sub> conductive glass. Figure 10 Shows that the efficiencies for electrodes mixed with PANI in general is higher than that for carbon electrode. The efficiency of PANI on SnO<sub>2</sub> is closer with PANI on ITO.

In other hand when compare in cost, the SnO<sub>2</sub> conductive glass has lower cost than that for ITO conductive glass in the same dimensions by ratio 1:5 which give to SnO<sub>2</sub> preference where can fabrication more than 5 cells with SnO<sub>2</sub> in the same cost for one cell with ITO.



**Figure 10:** I-V characteristics of DSSC with three types of counter electrode carbon, PANI on ITO and PANI on SnO<sub>2</sub> conductive glass

## Conclusions

In addition to fabricate the electrochemical polymerization of aniline can be conducted easily on SnO<sub>2</sub> coated glass that we prepared it by spray pyrolysis and the examinations revealed Nano-fiber structure with diameter around 72.23 nm. The adhesion of PANI on SnO<sub>2</sub> is more large than that for ITO because the roughness of surface SnO<sub>2</sub> is larger than that ITO surface. Also by used SnO<sub>2</sub> conductive glass may reduce the cost by far.

## References

M. Grätzel (2005), Solar energy conversion by dye-sensitized photovoltaic cells, *Inorg. Chem.*, Vol. 44 (20), pp. 6841-6851  
 J. Frank and N. Kopidakis (2004), Electrons in nanostructured TiO<sub>2</sub> solar cells: transport, recombination and photovoltaic properties, *Coordination Chem. Rev.*, vol. 248, pp. 1165-1179.  
 M. Grätzel (2000), Perspectives for Dye-sensitized Nanocrystalline Solar Cells, *Prog. Photovolt. Res. Appl.*, Vol 8, pp. 171-185.

Gordon G. Wallace and *et al.* (2008), Conductive Electroactive Polymers: Intelligent Polymer Systems, *CRC Press*, Third Edition.

Inzelt Gyotöy (2012), Conducting Polymers, 2nd, *Springer-Verlag*, Berlin, Heidelberg, 2012.

Sreekala and *et al.* (2013), New analytical approach to the insulator-metal transition in conductive polyaniline. *Synthetic Metals*, Vol. 160, pp. 1668-1671.

Macdiarmid A. and *et al.* (1987), Polyaniline: Protonic acid doping of the emeraldine form to the metallic regime, *Synthetic Metals*, Vol. 18, pp. 285-290.

Chandra Sekharan Nair Omana Amma Sreekala and *et al.* (2013), Functionalized multi-walled carbon nanotubes for enhanced photocurrent in dye-sensitized solar cells, *Journal Of Nanostructure in Chemistry*, doi:10.1186/2193-8865, pp.3-19.

S.Ameen and *et al.* (2010), Fabrication, Doping and Characterization of Polyaniline and Metal Oxides: Dye Sensitized Solar Cells, *Sci. Adv. Mater.*, Vol. 2, pp. 441-462.

A. Sadia, A.M. Shaheer and *et al.* (2011), Solar Cells - Dye-Sensitized Devices, *InTech*, ISBN: 978-953-307-735-2.

Kareem Najim Abed (2014), Preparation and Identification of TiO<sub>2</sub> Nanotubes (TNT's) For Solar cell, MSc Thesis, *the College of Science, University of Baghdad*.

A M Pharhad Hussain and A. Kumar (2003), Electrochemical synthesis and characterization of chloride doped polyaniline, *Mater.sci.* Vol. 26 (3), pp. 329-334.

J. Vivekanandan and *et al.* (2011), Synthesis, characterization and conductivity study of polyaniline prepared by chemical oxidative and electrochemical methods, *Archives of Applied Science Research*, Vol.3 (6):P.147-153, 2011.

J. Vivekanandan and *et al.* (2011), Synthesis, characterization and conductivity study of polyaniline prepared by chemical oxidative and electrochemical methods, *Archives of Applied Science Research*, Vol. 3 (6), pp. 147-153.

Y.Cao, P. Smith and A.J Heeger (1989), Spectroscopic Studies of Polyaniline in Solution and In Spin Cast Film, *Synthetic Metals*, Vol. 32, pp. 263-281.

M. Wan (2004), In Encyclopaedia of Nanoscience and Nanotechnology, H. S. Nalwa, (Ed.), *American Scientific Publishers*, Vol. 2, pp. 153-169.